

USE and MAINTENANCE INSTRUCTION MANUAL

- **WS-400 EVO**
- **LS-400 Entech**

GRAVITY  
SPRAY GUN Series







designed by *pininfarina*



LS-400  
entech

WS-400  
EVO

**TECHNICAL DATA WS-400**









WS-400 EVO		 Ø mm	 No.	 bar	 mL/min	 NL/min	 mm	 mm		
<b>WS-400 Clear</b>	WS-400 -1301 EVO	1.3	WS-400-01	2.0	170	370	Spray Distance 130 mm	260	Spray Distance 200 mm	365
	WS-400 -1401 EVO	1.4			190			370		
	WS-400 -1301HD EVO	1.3 HD (1.3.2)			220			265		365
	WS-400 -1401HD EVO	1.4 HD (1.4.2)			240			270		370
	WS-400 -1501HD EVO	1.5 HD (1.5.2)			260			275		370
<b>WS-400 Base</b>	WS-400 -1201 EVO	1.2	WS-400-01	2.0	120	370	Spray Distance 130 mm	250	Spray Distance 200 mm	350
	WS-400 -1301 EVO	1.3			140			260		365
	WS-400 -1401 EVO	1.4			170			265		365
	WS-400 -1301HD EVO	1.3 HD (1.3.2)			220			270		365
	WS-400 -1401HD EVO	1.4 HD (1.4.2)			240			275		370
	WS-400 -1501HD EVO	1.5 HD (1.5.2)			260			260		370
	WS-400 -1301OBS EVO	1.3 OBS			160			260		365

• HD ( High Delivery) • OBS (Optimised Basecoat Setting)

**NOZZLE\_NEEDLE SET COMBIINATION**

Fluid Nozzle		Fluid Needle
Size	Mark	Mark
1.2	WS400/12	40012
1.3 BASE	WS400/13Base	
1.3 CLEAR	WS400/13Clear	20015
1.4 BASE	WS400/14Base	
1.4 CLEAR	WS400/14Clear	
1.3 HD (1.3.2)	WS400/13 HD	
1.4 HD (1.4.2)	WS400/14 HD	
1.5 HD (1.5.2)	WS400/15 HD	
1.3 OBS	WS400/13 OBS	

**TECHNICAL DATA LS-400**

LS-400 Entech		 Ø mm	 No.	 bar	 mL/min	 NL/min	 mm	 mm	 mm					
<b>LS-400 ET</b>	LS-400-1205	1.2 ET	LS-400-05	1.8	150	400	Spray Distance at 130 mm	250	Spray Distance at 200 mm	350				
	LS-400-1305	1.3 ET						160		250	350			
	LS-400-1405	1.4 ET						170		260	360			
	LS-400-1505	1.5 ET						180		265	365			
<b>LS-400 ETS</b>	LS-400-ETS12	1.2 ETS			420	150	420	Spray Distance at 130 mm	230	Spray Distance at 200 mm	305	Spray Distance at 300 mm	390	
	LS-400-ETS13	1.3 ETS							160		235		310	400
	LS-400-ETS14	1.4 ETS							180		235		310	410
	LS-400-ETS15	1.5 ETS							190		240		320	425

• ET: Standard Distance • ETS: Wetter & Longer Spray Distance

**NOZZLE\_NEEDLE SET COMBIINATION**

Fluid Nozzle		Fluid Needle
Size	Mark	Mark
1.2 ET	LS400/ ET12	20015
1.3 ET	LS400/ ET13	
1.4 ET	LS400/ ET14	
1.5 ET	LS400/ ET15	
1.2 ETS	LS400/ ETS12	
1.3 ETS	LS400/ ETS13	
1.4 ETS	LS400/ ETS14	
1.5 ETS	LS400/ ETS15	



Before use, adjustment or maintenance, it is important to read this instruction manual very carefully. This manual must be stored in a safe place for any future reference.

This ANEST IWATA spray guns kit complies to ATEX regulations 2014/34/EU.



Protection level: II 2G X Suitable for using Zones 1 and 2.

X marking: Any static electricity discharge from the spray gun is to be diverted to the ground via the conductive air hose as stipulated.



**ALWAYS observe WARNINGS and CAUTIONS in this instruction manual.**

Symbol	WARNING	Hazard level	Consequence
	<b>WARNING</b>	Potentially hazardous situation	Death or serious injury
	<b>CAUTION</b>	Potentially hazardous situation	Minor to moderate injury
	<b>IMPORTANT</b>	Potentially hazardous situation	Property damage

## 1. TECHNICAL SPECIFICATIONS

Max. working air pressure:	7.0 bar (100 PSI)
Weight g (lbs): (without cup)	475 (1.05)
Noise level (LAeqT)*:	75.8 dB(A)
Air Connection	G1/4" M
Fluid Connection	G1/4" F
Max. Temperature range:	Atmosphere 5 ~ 40 °C / Air-Fluid 5 ~ 43 °C
* Measuring point: 1m backwards from gun, 1.6m height.	

## 2. SAFETY WARNING FIRE AND EXPLOSION



- Never use the following HALOGENATED HYDROCARBON SOLVENTS:** which can cause cracks or dissolution of gun body (aluminium) due to chemical reaction. UNSUITABLE SOLVENTS: methyl chloride, dichloromethane, 1,2-dichloroethane, carbon tetrachloride, trichloroethylene, 1,1,1-trichloroethane
- Sparks and open flames are strictly prohibited.** Paints can be highly flammable and can cause fire. Do not expose to open flames, electrical goods, cigarettes etc.
- Securely ground spray gun using conductive air hose.** (Less than 1MΩ)  
Always ensure that the spray gun is earthed correctly.

### PROTECTION OF HUMAN BODY



- Use in a well-ventilated site, using a spray booth.**  
Poor ventilation can cause organic solvent poisoning and fire.
- Always wear protective gear (safety glasses, mask, gloves) to avoid inflammation of eyes and skin.**  
In case of any physical discomfort, immediately seek medical advice.
- Wear earplugs if necessary.**  
Noise level can exceed 80 dB(A), depending on operating conditions and painting site.
- Pulling the trigger many times during operation, may cause carpal tunnel syndrome.** Always rest, in case of tiredness.

## IMPROPER USE



- Never point gun towards people or animals.**
- Never exceed maximum working pressure or maximum operating Temperature**
- Always release air and fluid pressure before cleaning, disassembling or servicing.** Otherwise, remaining pressure can cause bodily injury due to improper operation or scattering of cleaning liquid.
- Tip of fluid needle set has a sharp point.**  
Do not touch the tip during maintenance to avoid accidents.
- Never use this gun to spray foods or chemicals.** Otherwise, foreign substance, could cause corrosion of fluid passages which could adversely affect health.
- Never alter this spray gun,** to avoid insufficient performance and damage.
- If something goes wrong, immediately stop operation and find the cause. Do not use again, until you have solved the problem.**
- Do not enter working areas, where robots, reciprocators, etc. are used, until they have been turned off.** Otherwise, they could cause injury.

## 3. HOW TO CONNECT

### CAUTION



- Use clean air filtered through air dryer and air filter.
  - When using this gun for the first time after purchase, adjust fluid needle packing set, spray cleaner to clean fluid passages and remove rust preventive oil.
  - Firmly fix container to spray gun, to avoid that disconnection of it, can cause bodily injury.
- Firmly connect an air hose to air nipple 1/4"(4-2).
  - Firmly connect a suitable cup to fluid nipple (4-1).
  - Flush fluid passages with a compatible cleaner.
  - Pour paint into container, test spray, adjust fluid output and pattern width.

## 4. HOW TO OPERATE

- Suggested atomizing air pressure is 1.5 to 2.5 bar (21 to 36 PSI).
- Recommended paint viscosity differs according to paint property and painting conditions. 14 to 25 sec. / Ford cup#4 is recommended.
- Set the spray distance from the gun to the work piece, as near as possible within the range of 130-200 mm.
- The gun should be held so that it is perpendicular to the surface of the workpiece at all times. Then, the gun should move in a straight and horizontal line. Arcing the gun causes uneven painting.

## 5. MAINTENANCE AND INSPECTION

### CAUTION



Before carrying out maintenance and inspection ALWAYS observe warning indications.

- Never remove baffle ring from gun body.
- Never use spare parts that are not Anest Iwata originals.
- Never damage fluid nozzle tip, fluid needle or air cap holes.
- Never immerse the spray gun completely in liquids such as thinner.

### 5.1 MANUAL CLEANING PROCEDURE



The fluid passages of the gun, must be cleaned thoroughly after each use, especially after use with bi-component paints. Incomplete cleaning can cause defective pattern shape.

- **Never soak air cap set (1) in cleaner for an extended period, even when cleaning.**
  - **Never use metal brush to clean the gun.**
1. Drain remaining paint from spray gun and cup, into a suitable container.
  2. Pour cleaner into cup.
  3. Unscrew air cap (1) by 2 turns, to allow atomizing air to back flush, fluid passages of the gun.
  4. Pull trigger (16) and make sure, that atomizing air enters cup.
  5. Leave cleaner for a few seconds, then empty it into suitable waste container.
  6. Repeat procedure above, until spray gun is clean.
  7. Remove air cap (1) and cup from gun, then clean each section with brush soaked with cleaner and wipe out with waste cloth.
  8. DRY ALL PARTS completely and apply spray gun lubricant to each thread.

## 5.2 AUTOMATIC CLEANING PROCEDURE

- **When using automatic spray gun washer, follow the instruction manual provided with it. Before cleaning, make sure air is released from air passages.**
- **Only use suitable cleaner designed for your spray gun washer.**
- **Make sure that the equipment is dried immediately after cleaning.**
- **Do not leave spray guns inside spray gun washer, after cleaning.** Cleaner vapour can damage packings and cause corrosion inside gun body.
- **Do not leave spray guns soaking in cleaner.**
- **Securely ground washer equipment.** Use of cleaner with waterborne coatings, can increase PH level, especially after several cleanings. Please, replace the cleaner regularly in order to always ensure the best spray gun performance.
- **Make sure that the PH level of cleaner does not exceed the limit.** PH level: 6.0~8.0 (but only during cleaning).

## 5.3 DISASSEMBLY PROCEDURE

- **Before disassembly, fully clean fluid passages.**



- a. Disassemble fluid nozzle (2-1), while keeping fluid needle (2-2) pulled (triggering) in order to protect its seat section.
- b. Disassemble fluid needle set (2-2). (only when strictly necessary)

- c. Remove fluid adj. knob (13), fluid adj. set (12) and needle spring (11), extracting the spring and fluid needle set (2-2), from the back of fluid adj. guide set (10) still assembled on the gun body (4).

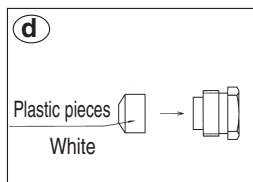
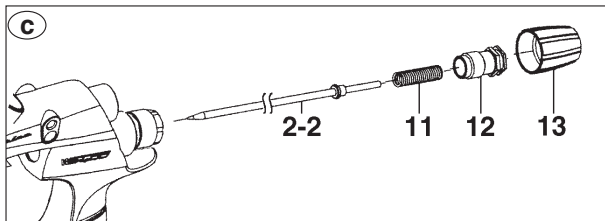

- d. Fluid needle packing set (3), must always be adjusted while fluid needle set (2-2) is inserted and in the following way: tighten it by hand (about a 60 degree turn) and then with spanner. When you remove needle packing set (3), do not leave plastic piece of needle packing set (3) in the gun body.

- If you tighten fluid needle packing set (3) too much, fluid needle set (2-2) will not move smoothly, resulting in paint leakage from tip of fluid nozzle (2-1).
- Try to adjust it carefully while pulling trigger and confirming movement of fluid needle set (2-2).
- If you tighten it too much, repeat operation.

- e. **Air valve assembly (8)**, assemble air valve (8), air valve spring (9) and fluid adj. guide set (10) together. Next, insert fluid needle set (2-2) into fluid adj. guide set (10), fit it to gun body set (4) and screw fluid adj. guide set (10).
- If you try to fit air valve spring (9) and air valve (8) to gun body set (4) without fluid needle set (2-2), air valve (8) will not be fitted correctly and the packing in the fluid adj. guide set (10) will be damaged.

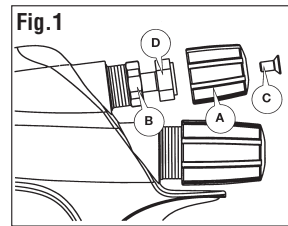
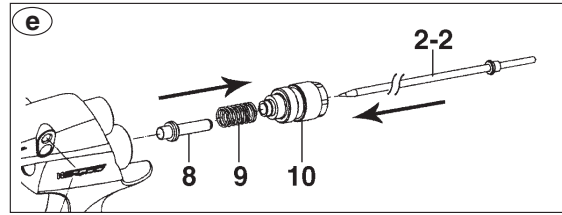

- f. **Disassembly of pattern adjustment set (5) and/or air adjustment set (15).** In order to disassemble pattern adj. set (5) and/or air adj. set (15), first of all unscrew countersunk socket head screw Torx T10(C) and remove adjustment knob (A) by pulling out it carefully, as illustrated in Fig.1. Then manually turn the hexagon knob (D) of the adjustment counterclockwise to open it completely and unscrew the hexagon face (B) with a spanner turning it counterclockwise.

- To reassemble pattern adjustment set (5) and/or air adjustment set (15), reverse the procedure.

**IMPORTANT: Before reassembling pattern adjustment set and/or air adjustment set, make sure that these operations are carried out with the adjustment fully open (Fig.1).**

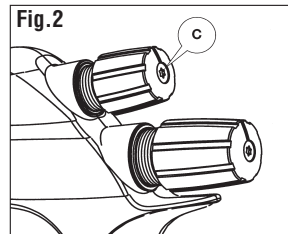

**WARNING: When you reinsert the knob (6) on the adjustment (B) and before to tighten the countersunk socket screw (C), make sure that it is pushed in until it completely covers the face of the hexagon knob of the adjustment (Fig.2).**

## 5.4 INSPECTION & REPLACEMENT STANDARD

WHERE TO INSPECT	REPLACEMENT PART
a. Each hole passage of air cap (1) and fluid nozzle (2-1).	Replace if it is crushed or deformed.
b. Packing and O ring	Replace if it is deformed or worn out.
c. Leakage from seat section between fluid nozzle (2-1) and fluid needle set (2-2).	Replace them if leakage does not stop after fully cleaning fluid nozzle (2-1) and fluid needle set (2-2).  If you replace fluid nozzle (2-1) or fluid needle set (2-2) only, fully match them and confirm that there is no leakage.

## 6. TROUBLESHOOTING

### GUN DOES NOT SPRAY



- Fluid adj. knob (13) closed. Check and adjust.
- Tip hole of nozzle obstructed. Check and clean.
- Paint filter obstructed. Check and clean.
- Non drip obstructed. Check and clean.

### INTERMITTENT SPRAY PATTERN



- Air escapes from fluid nozzle (2-1). Check , clean & replace if necessary.
- Air escapes from fluid needle packing (3). Tighten.
- Air escapes from cup joint. Tighten.
- Dirt inside air cap (1). Clean.

### DEFECTIVE SPRAY PATTERN



- Dirty nozzle (2-1) or air cap (1). Clean carefully.
- Nozzle (2-1) or air cap (1) has been damaged. Replace If damaged.
- Fluid nozzle (2-1) is loose. Tighten.
- Paint viscosity too high or too low. Dilute paint or increase viscosity
- Fluid output too high or too low. Adjust fluid adj. knob (13) to reduce or increase.

### LEAKING



- Fluid nozzle (2-1), needle set (2-2) or gun body (4), dirty, damaged or worn on seat. Clean or replace if necessary.
- Dirt inside air cap (1). Clean.
- Loose fluid adj. knob (13). Adjust.
- Fluid needle spring (11) is worn. Replace.
- Loose fluid nozzle (2-1). Tighten.
- Needle packing set (3) loose, too tight, dirty or worn. Adjust, clean or replace.

### AIR ESCAPES FROM AIR CAP

- Air valve (8), air valve seat (7) or air valve spring (9) dirty or damaged. Clean or replace if necessary.
- Air valve seat set o ring (7-1) damaged or worn. Replace.

## 7. SPARE PARTS LIST

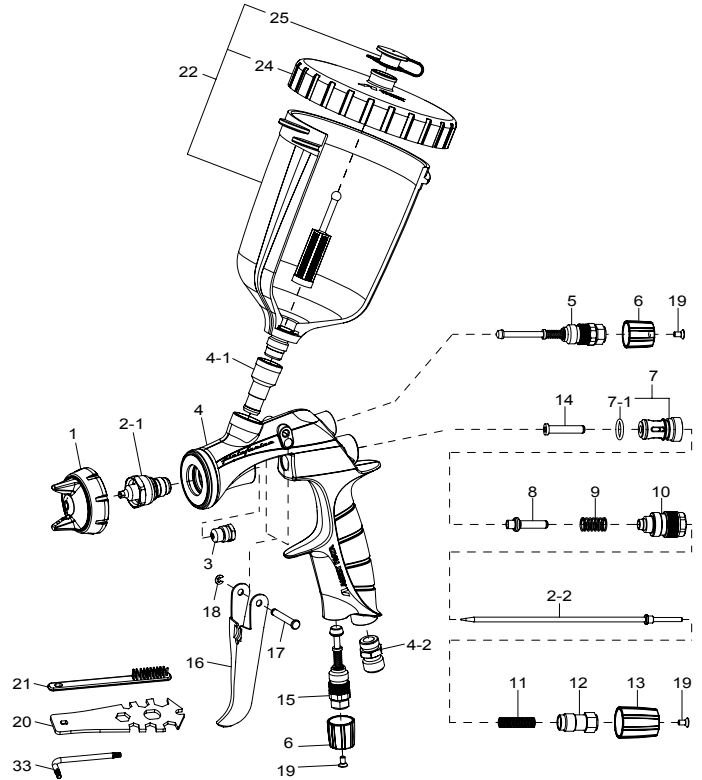

REF.	DESCRIPTION	
1	Air cap	
2	Fluid Nozzle + Fluid needle set	●
2-1	Fluid Nozzle	●
2-2	Fluid needle	●
3	Needle packing set	●
4	Body set	
4-1	Fluid nipple	▲
4-2	Air nipple	▲
5	Pattern adjustment set	
6	Adjustment knob	
7	Air valve seat *	
7-1	O'ring	●
8	Air valve	●
9	Air valve spring	
10	Fluid adjustment guide	
11	Needle spring	
12	Fluid adjustment screw	
13	Fluid adjustment knob	
14	Air valve shaft	●
15	Air adjustment set	
16	Trigger	
17	Trigger stud	
18	E stopper	
19	Countersunk socket screw (Torx T10)	
20	Spanner	
21	Brush	
22	Cup 600 ml	
24	Lid	
25	Non drip	
33	Allen wrench	
	Filter (optional)	

● Marked parts are wearable parts.

▲ Remove the following parts, only in case of repair and by qualified personnel.

**\*ATTENTION:** To disassemble Air valve seat\_ part.7, use 10 mm allen wrench (Non ball point type).

**NOTE:** When ordering parts, specify gun model, part name with No. and marked No. of air cap set, fluid nozzle and fluid needle.